

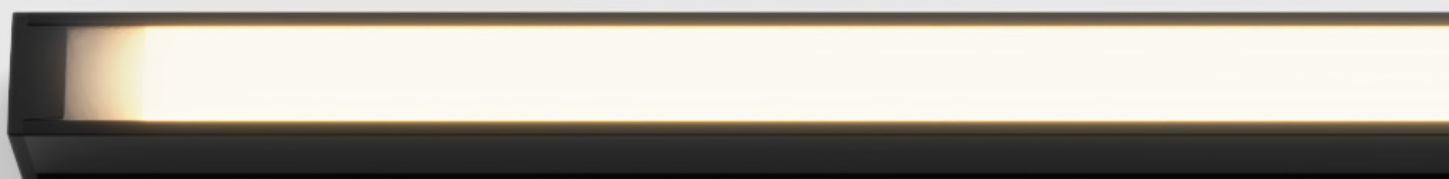

ALTO IP

LED STRIP STR-ALTO IP





The Alto IP LED strip is where value and performance go hand-in-hand. The Alto IP offers the best bang for your buck on projects where the key consideration is efficacy, lumen output and value.

The Alto IP offers a completely uniform glowing diffuser where no dots or scalloping is visible along the length of the luminaire or the illuminated surface.

POWER

11W

11.2W / metre



P20T

16W

16.8W / metre



P20T

33W

33.6W / metre



P20T

COLOUR TEMPERATURE

2700K

3000K

4000K

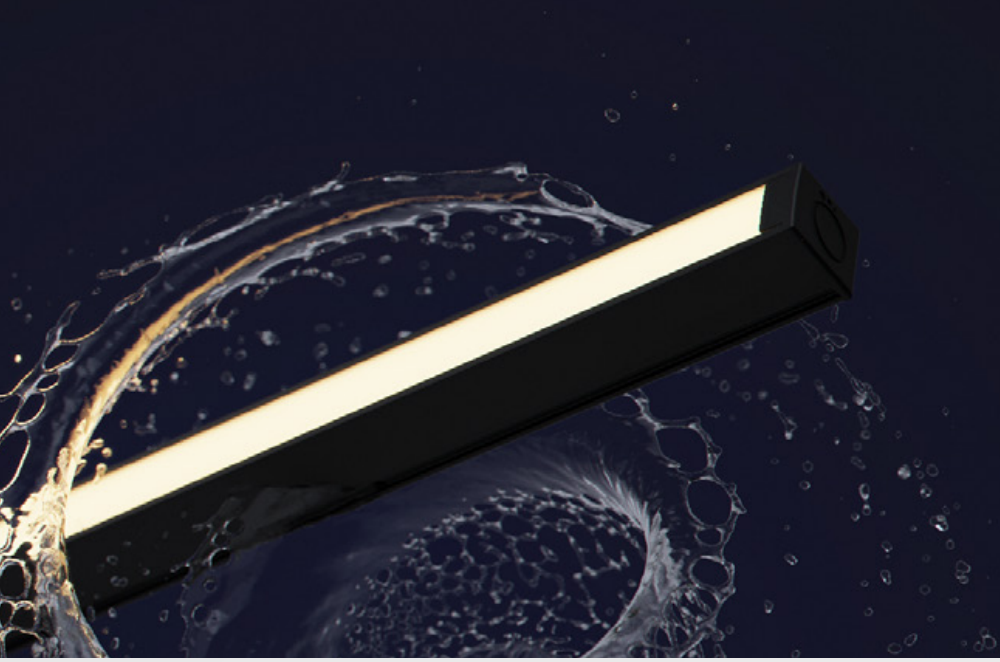

ELEGANT ENCAPSULATION

Alto IP utilises Coolon's encapsulation technology to deliver a truly extraordinary outdoor luminaire. IP66, IK08, shock and abrasion resistance, thermal protection, and dashing good looks, all in one.

HIGHLY VERSATILE LENGTH OPTIONS

Highly versatile length options allows the user to achieve much more accurate and adaptable lengths. The Alto IP is able to achieve any desired length within a 37.5mm increment.



LONG OPERATING LIFE

Coolon products use the world's most reputable LED manufacturers and the latest available standards to adequately report lumen maintenance. We strive to drive LEDs under their nominal current and use state-of-the-art heat dissipation methods, leading to durable electronics.



VARIOUS CCT & COLOUR BINNING CONSISTENCY

All products are offered in various colour temperatures, and manufactured using tighter bins, ensuring excellent consistency and uniformity.



5 YEARS WARRANTY

Coolon luminaires are covered by a solid comprehensive manufacturer's warranty that covers a range of possible defects and performance parameters throughout the duration of the warranty period.









PROUDLY MADE IN AUSTRALIA

Our products are designed and manufactured in Australia. Engineered to perfection, using only the highest quality components and highly skilled labour, each luminaire is assembled and thoroughly tested to ensure that it exceeds the highest standards.

TECHNICAL SPECIFICATIONS

	11W VERSION	16W VERSION	33W VERSION
Part Number	STR-ALTO IP		
Description	Alto IP Low Power LED Strip		
Segment Length (S)	300mm		
Sub-Segment Length (A)	37.5mm		
Number of Sub-Segments	8		
Segment Width	10.50mm		
LED Pitch	5.35mm		
LEDs Per Segment	56		
LEDs Per Sub Segment	7		
Operating Voltage	42VDC		
Typical Power Consumption per Segment	3.3W	5W	10W
Typical Power Consumption per Metre	11.2W/Metre	16.8W/Metre	33.6W/Metre
Colour Rendering Index (CRI)	80 (Standard) up to 90		
Dimmable	Through DRV-DALIPOINT-1X5A, DRV-DALIPOINT-1X10A-IP or DRV-DIMMERPOINT-1X10A (sold separately)		
Effective Beam Angle	120°		
External Heatsink Required	No		
Ambient Operating Temperature	Ta -40°C to 40°C		
Reported Lumen Maintenance TM21-11 (@ Ts = 55°C, If = 65mA)	L70 (12K) > 72,000 hours L90 (12K) = 59,000 hours Alto max. operating values (@ Ts = 40°C, If = 30mA)		
IP Rating	IP66		
IK Rating	IK08		
Max Continuous Connection Length	Please refer to installation limitations		

LUMEN / METRE MATRIX

POWER	LUMINOUS FLUX		
11W 11.2W / metre	2700K	3000K	4000K
P20T Profile (White) 	979 lm / metre	979 lm / metre	990 lm / metre
P20T Profile (Black) 	418 lm / metre	418 lm / metre	418 lm / metre
16W 16.8W / metre			
P20T Profile (White) 	1,424 lm / metre	1,424 lm / metre	1,440 lm / metre
P20T Profile (Black) 	608 lm / metre	608 lm / metre	608 lm / metre
33W 33.6W / metre			
P20T Profile (White) 	2,805 lm / metre	2,805 lm / metre	2,838 lm / metre
P20T Profile (Black) 	1,122 lm / metre	1,122 lm / metre	1,122 lm / metre

✘ : CCT / Profile combination NOT AVAILABLE NM : Lumen output NOT MEASURED

■ DIMENSIONS

For final strip lengths please refer to the "Product Length" table.

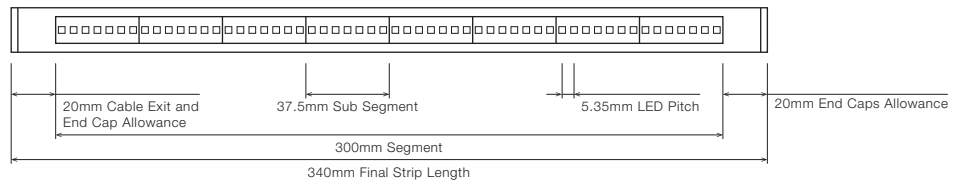

P20T PROFILE

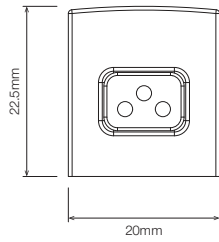

WITH STAINLESS STEEL C-CLIP ¹

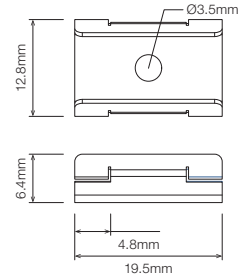
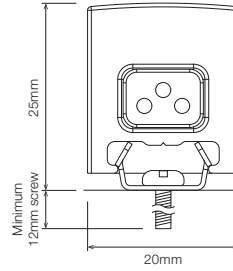

ROTATING MOUNTING BRACKET, TYPE A/B ROTATING CLIP ¹

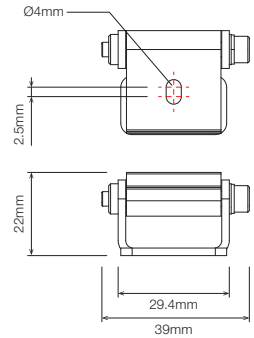
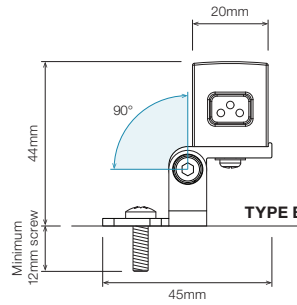
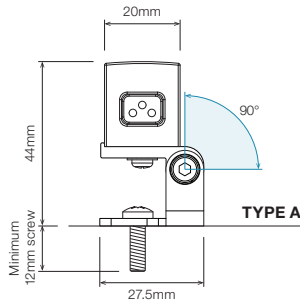

¹ Recommended spacing between Mounting Brackets is maximum 500mm and Mounting Clips is maximum 300mm.

PRODUCT LENGTH

FULL SEGMENTS	SUB SEGMENTS	EXACT STRIP LENGTH	END CAP ALLOWANCE	FINAL LENGTH
S0	A1	37.5mm	add 40mm	77.5mm
S0	A2	75mm	add 40mm	115mm
S0	A3	112.5mm	add 40mm	152.5mm
S0	A4	150mm	add 40mm	190mm
S0	A5	187.5mm	add 40mm	227.5mm
S0	A6	225mm	add 40mm	265mm
S0	A7	262.5mm	add 40mm	302.5mm
S1	A0	300mm	add 40mm	340mm
S1	A1	337.5mm	add 40mm	377.5mm
S1	A2	375mm	add 40mm	415mm
S1	A3	412.5mm	add 40mm	452.5mm
S1	A4	450mm	add 40mm	490mm
S1	A5	487.5mm	add 40mm	527.5mm
S1	A6	525mm	add 40mm	565mm
S1	A7	562.5mm	add 40mm	602.5mm
S2	A0	600mm	add 40mm	640mm
S2	A1	637.5mm	add 40mm	677.5mm
S2	A2	675mm	add 40mm	715mm
S2	A3	712.5mm	add 40mm	752.5mm
S2	A4	750mm	add 40mm	790mm
S2	A5	787.5mm	add 40mm	827.5mm
S2	A6	825mm	add 40mm	865mm
S2	A7	862.5mm	add 40mm	902.5mm
S3	A0	900mm	add 40mm	940mm
S3	A1	937.5mm	add 40mm	977.5mm
S3	A2	975mm	add 40mm	1,015mm
S3	A3	1,012.5mm	add 40mm	1,052.5mm
S3	A4	1,050mm	add 40mm	1,090mm
S3	A5	1,087.5mm	add 40mm	1,127.5mm
S3	A6	1,125mm	add 40mm	1,165mm
S3	A7	1,162.5mm	add 40mm	1,202.5mm
S4	A0	1,200mm	add 40mm	1,240mm
S4	A1	1,237.5mm	add 40mm	1,277.5mm
S4	A2	1,275mm	add 40mm	1,315mm
S4	A3	1,312.5mm	add 40mm	1,352.5mm
S4	A4	1,350mm	add 40mm	1,390mm
S4	A5	1,387.5mm	add 40mm	1,427.5mm
S4	A6	1,425mm	add 40mm	1,465mm
S4	A7	1,462.5mm	add 40mm	1,502.5mm
S5	A0	1,500mm	add 40mm	1,540mm

➔ Continued on next page

⚠ WARNING

Do not bend LED strip when removing from mounting clips.

Gently twist LED Strip to remove from mounting clips.

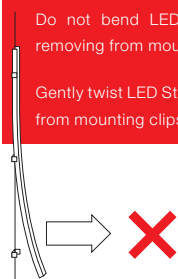

⚠ WARNING

PLEASE HANDLE LONG LED STRIPS WITH CARE.

LED Strips must not be bent.

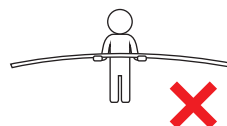

When handling LED Strips, please ensure that they are kept straight.

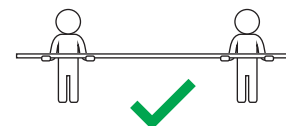

PRODUCT LENGTH

(CONTINUED)

FULL SEGMENTS	SUB SEGMENTS	EXACT STRIP LENGTH	END CAP ALLOWANCE	FINAL LENGTH
S5	A1	1,537.5mm	add 40mm	1,577.5mm
S5	A2	1,575mm	add 40mm	1,615mm
S5	A3	1,612.5mm	add 40mm	1,652.5mm
S5	A4	1,650mm	add 40mm	1,690mm
S5	A5	1,687.5mm	add 40mm	1,727.5mm
S5	A6	1,725mm	add 40mm	1,765mm
S5	A7	1,762.5mm	add 40mm	1,802.5mm
S6	A0	1,800mm	add 40mm	1,840mm
S6	A1	1,837.5mm	add 40mm	1,877.5mm
S6	A2	1,875mm	add 40mm	1,915mm
S6	A3	1,912.5mm	add 40mm	1,952.5mm
S6	A4	1,950mm	add 40mm	1,990mm
S6	A5	1,987.5mm	add 40mm	2,027.5mm
S6	A6	2,025mm	add 40mm	2,065mm
S6	A7	2,062.5mm	add 40mm	2,102.5mm
S7	A0	2,100mm	add 40mm	2,140mm
S7	A1	2,137.5mm	add 40mm	2,177.5mm
S7	A2	2,175mm	add 40mm	2,215mm
S7	A3	2,212.5mm	add 40mm	2,252.5mm
S7	A4	2,250mm	add 40mm	2,290mm
S7	A5	2,287.5mm	add 40mm	2,327.5mm
S7	A6	2,325mm	add 40mm	2,365mm
S7	A7	2,362.5mm	add 40mm	2,402.5mm
S8	A0	2,400mm	add 40mm	2,440mm
S8	A1	2,437.5mm	add 40mm	2,477.5mm
S8	A2	2,475mm	add 40mm	2,515mm
S8	A3	2,512.5mm	add 40mm	2,552.5mm
S8	A4	2,550mm	add 40mm	2,590mm
S8	A5	2,587.5mm	add 40mm	2,627.5mm
S8	A6	2,625mm	add 40mm	2,665mm
S8	A7	2,662.5mm	add 40mm	2,702.5mm
S9	A0	2,700mm	add 40mm	2,740mm
S9	A1	2,737.5mm	add 40mm	2,777.5mm
S9	A2	2,775mm	add 40mm	2,815mm
S9	A3	2,812.5mm	add 40mm	2,852.5mm
S9	A4	2,850mm	add 40mm	2,890mm
S9	A5	2,887.5mm	add 40mm	2,927.5mm
S9	A6	2,925mm	add 40mm	2,965mm
S9	A7	2,962.5mm	add 40mm	3,002.5mm

Confirm interstate courier compliance

Custom length subject to availability

WARNING

Do not bend LED strip when removing from mounting clips.

Gently twist LED Strip to remove from mounting clips.

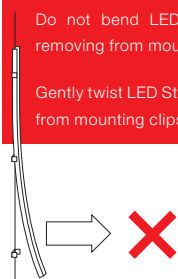

WARNING

PLEASE HANDLE LONG LED STRIPS WITH CARE.

LED Strips must not be bent.

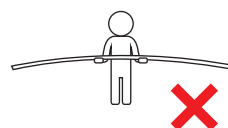

When handling LED Strips, please ensure that they are kept straight.

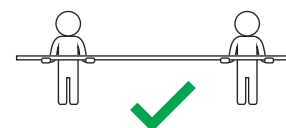

PROFILE / DIFFUSER

P20T - P20 Profile Diffused



PROFILE COLOUR

BLK - Black (Standard)



WHT - White



CST - Custom Colour ¹

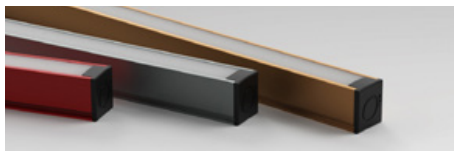

WIRING CONFIGURATION

CONNECTOR TYPE	DRAWING	MALE	FEMALE
OC2MO Connector 2pin Male Only			
OC2MF Connector 2pin Male + Female			
SMP LC Sample Type Connector 2.5mm			

- For detailed information on Outdoor IP67 connector please contact Coolon.
- Please consult Coolon for details on extension cable between LED fittings, drivers and power supplies.

WIRING COLOUR CODE	
Red	+ VDC
Black	GND

IP RATING

IP66

Fully protected against dust.
Protected against wave-like
water jets from all directions.

¹ Custom colours available on request.

■ INSTALLATION LIMITS

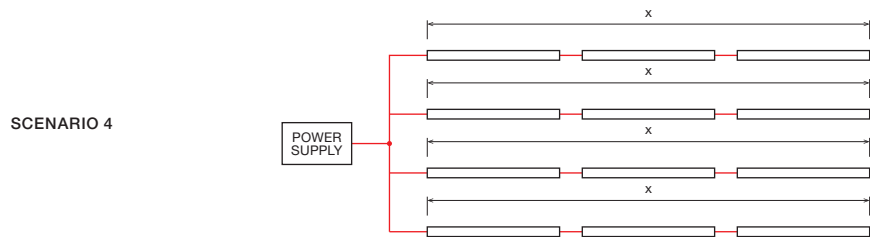
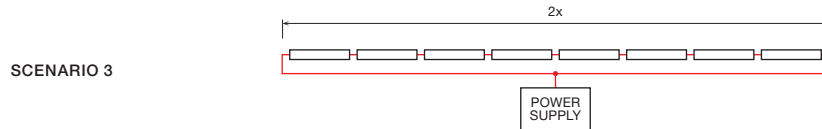
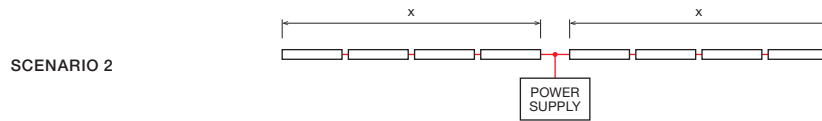
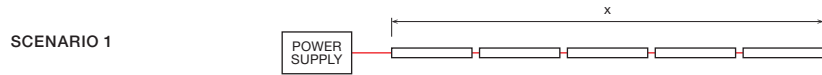

11W VERSION

MAX. CONTINUOUS CONNECTION LENGTH (X)	CONNECTOR TYPE
9,000 mm	With outdoor 2 pin connectors (OC2MO / OC2MF)

▪ Please consult Coolon for details on extension cable between LED fittings, drivers and power supplies.

16W VERSION

MAX. CONTINUOUS CONNECTION LENGTH (X)	CONNECTOR TYPE
6,000 mm	With outdoor 2 pin connectors (OC2MO / OC2MF)

▪ Please consult Coolon for details on extension cable between LED fittings, drivers and power supplies.

33W VERSION

MAX. CONTINUOUS CONNECTION LENGTH (X)	CONNECTOR TYPE
3,000 mm	With outdoor 2 pin connectors (OC2MO / OC2MF)

▪ Please consult Coolon for details on extension cable between LED fittings, drivers and power supplies.

⚠ WARNING

Avoid connecting multiple power supplies into a single circuit, unless they are specifically designed to do so.

✗

✗

ORDERING EXAMPLE

STR - ALTO IP - 33W - 3.0K - S2A0 - P20T - WHT - OC2MO - 100 - IP66



WATTAGE PAGE 04

11W	11.2W per Metre
16W	16.8W per Metre
33W	33.6W per Metre

COLOUR TEMPERATURE ¹ PAGE 04

2.7K	2700K CRI 80
2.7KCRI	2700K CRI 90
3.0K	3000K CRI 80
3.0KCRI	3000K CRI 90
4.0K	4000K CRI 80
4.0KCRI	4000K CRI 90

PRODUCT LENGTH PAGE 06

FULL SEGMENTS	SUB SEGMENTS
S0	A0
S1	A1
S2	A2
S3	A3
S4	A4
S5	A5
S6	A6
S7	A7

PROFILE / DIFFUSER PAGE 08

P20T	P20 Profile Diffused
------	----------------------

PROFILE COLOUR PAGE 08

WHT	White (Standard)
BLK	Black
CST	Custom Colour

WIRING CONFIGURATION PAGE 08

OC2MO	Connector 2pin Male Only
OC2MF	Connector 2 pin Male + Female
SMPLC	Sample Type Connector 2.5mm

WIRING LENGTH PAGE 08





100	100mm
250	250mm

IP RATING PAGE 08

IP66	Outdoor Use
------	-------------

¹ Other CCT subject to availability.

■ ACCESSORIES

	PRODUCT CODE	DESCRIPTION
MOUNTING CLIP ¹		
	MC-CCLIP20	Stainless Steel C-Clip for P20 Profile
	MBR-RB-TA-P20-BLK	Rotating Bracket, TYPE A Rotating Clip - Black
	MBR-RB-TB-P20-BLK	Rotating Bracket, TYPE B Rotating Clip - Black
¹ Recommended spacing between Mounting Brackets is maximum 500mm and Mounting Clips is maximum 300mm.		
DRIVER		
	DRV-DALIPPOINT-1X5A	DALI 5 Amps 1 Channel LED Driver
	DRV-DALIPPOINT-IP1X10A	DALI 10 Amps 1 Channel Outdoor LED Driver
	DRV-DIMMERPOINT-1X10A	Rotary Wall-Mount LED Driver
	DRV-RDM-P4	DMX / RDM 4 Channel LED Driver
	DRV-RDM-IP-P4	Outdoor DMX / RDM 4 Channel LED Driver
POWER SUPPLY FOR OUTDOOR USE (IP67)		
	PWR-HLG-60H-42AU	Mean Well Power Supply HLG 60W 42V IP67
	PWR-HLG-150H-42AU	Mean Well Power Supply HLG 150W 42V IP67
	PWR-HLG-240H-42AU	Mean Well Power Supply HLG 240W 42V IP67
CABLE EXTENSIONS		
	CBLEXT-STR-OC2-IP65-0.6M	3m Connector Extension for Strips 1x Red, 1x Black, 0.75mm ² wires
	CBLEXT-STR-OC2-IP65-3M	5m Connector Extension for Strips 1x Red, 1x Black, 0.75mm ² wires
	CBLEXT-STR-OC2-IP65-5M	10m Connector Extension for Strips 1x Red, 1x Black, 0.75mm ² wires