

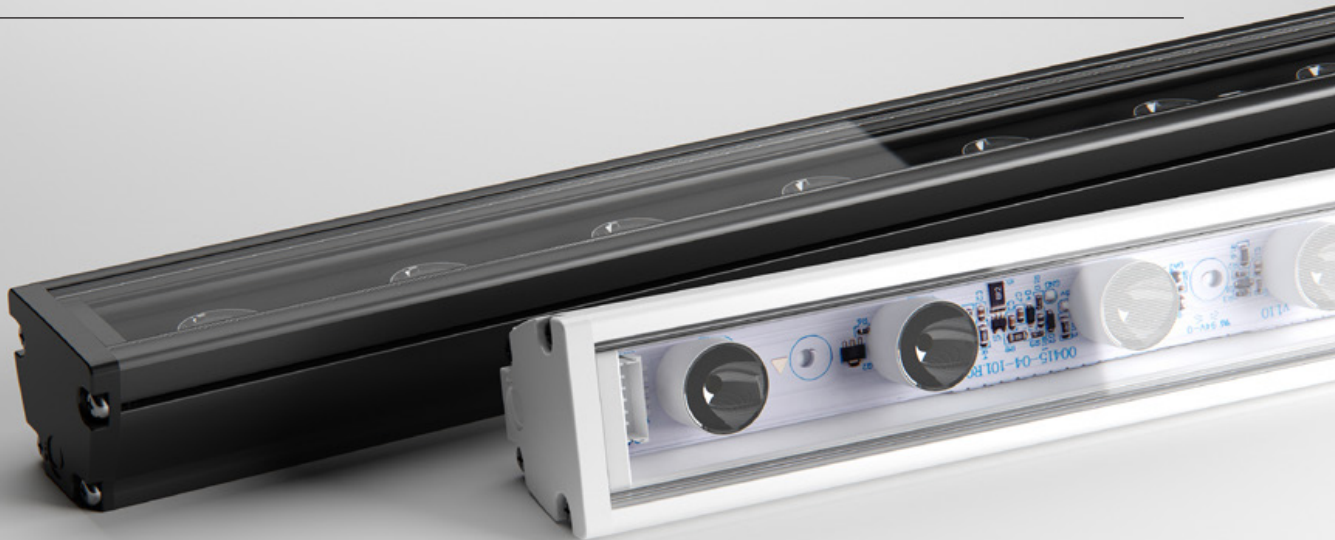

MAX MINI IP

LINEAR MEDIUM POWER LNR-MAX MINI IP





Max Mini IP is a medium-power outdoor luminaire with precision optics - available in a range of colour temperatures. Unique encapsulation methods and a robust form factor provide IP66/IK08 for unbeatable durability and resistance against exterior conditions.

Optic selection and the assistance of a range of brackets ensure easy installation and accurate aiming, allowing you to execute your design with precision.

POWER

LUMINOUS FLUX

33W
33W / metre



PC

HL - 1,315 lm / metre

ML

COLOUR TEMPERATURE

2700K

3000K

3500K

4000K

COMPACT SIZE

The reduced profile dimensions allow for ease of installation in confined spaces that could not be achieved with previous halogen counterparts. When installed in visible sight, Max Mini IP also pays respect to the interior design with minimal disruption to the aesthetics.



ELEGANT ENCAPSULATION

Max Mini IP utilises Coolon's encapsulation technology and signature build quality to deliver an outdoor luminaire that's uniquely resilient. IP66, IK08, shock and abrasion resistance and thermal protection just add to the appeal of this versatile all-star.



LONG OPERATING LIFE

Coolon products use the world's most reputable LED manufacturers and the latest available standards to adequately report lumen maintenance. We strive to drive LEDs under their nominal current and use state-of-the-art heat dissipation methods, leading to durable electronics



VARIOUS CCT & COLOUR BINNING CONSISTENCY

All products are offered in various colour temperatures, and manufactured using tighter bins, ensuring excellent consistency and uniformity.



5 YEARS WARRANTY

Coolon luminaires are covered by a solid comprehensive manufacturer's warranty that covers a range of possible defects and performance parameters throughout the duration of the warranty period.



PROUDLY MADE IN AUSTRALIA

Our products are designed and manufactured in Australia. Engineered to perfection, using only the highest quality components and highly skilled labour, each luminaire is assembled and thoroughly tested to ensure that it exceeds the highest standards.

TECHNICAL SPECIFICATIONS

Product Code	LNR-MAX MINI IP
Description	Max Mini IP Linear Medium Power Projector
Body	Aluminium Alloy Body
Finish	Powder Coated Black (Standard), Various Colours Available
Cover	Polyurethane Clear for Outdoor Applications
End Caps	Polycarbonate
Segment Length (S)	240mm
Segment Width	22mm
LED Pitch	40mm
LEDs Per Segment	6
Operating Voltage	24VDC
Typical Power Consumption per Segment	7.92W per 240mm Segment
Typical Power Consumption per metre	33.0W per metre
Typical Current	330mA per 240mm Segment
Colour Rendering Index (CRI)	90+
Dimmable	Through CTR-A2PWM 0-10V, CTR-DIMMERLOGIC, CTR-DALILOGIC or CTR-DALILOGIC-IP (sold separately)
Luminous Flux per Metre (lm/m)	1600lm/metre
External Heatsink Required	No
Ambient Operating Temp	Ta -40°C to 50°C
Thermal Operating	Yes (Active)
Reported Lumen Maintenance TM21-11 (@ Ts = 85°C, If = 500mA)	L70 (18K) > 109,000 hours L90 (18K) > 103,000 hours
	Max Mini max. operating values (@ Ts = 50°C, If = 325mA)
IP Rating	IP66 (Standard)
IK Rating	IK08
Max Continuous Connection Length	Please refer to installation limitations

COLOUR BINNING

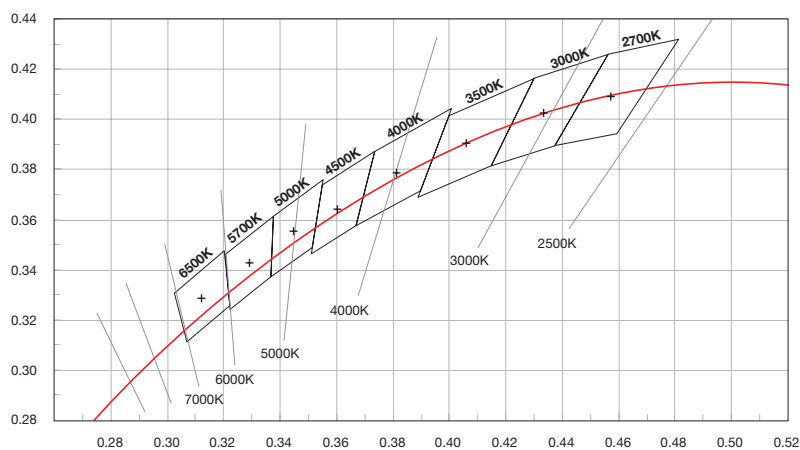

■ DIMENSIONS

For final strip lengths please refer to the "Product Length" table.

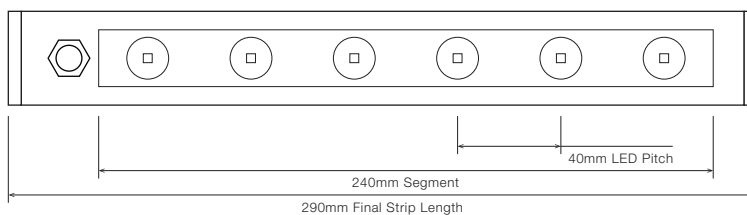

STANDARD PROFILE

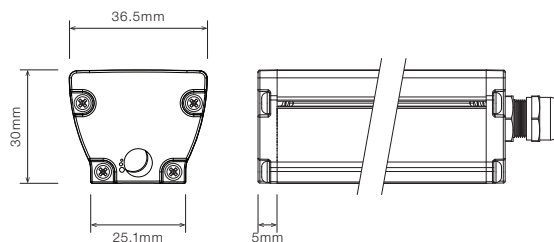

CABLE EXTENSION JOINER

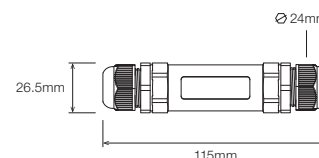

STAINLESS STEEL C-CLIP ¹

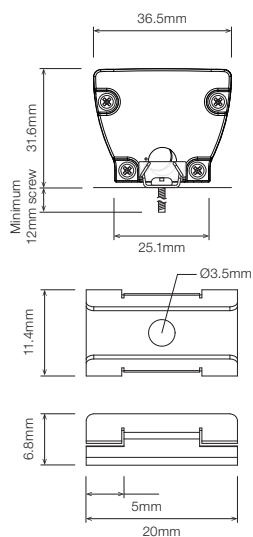

ROTATING MOUNTING BRACKET, TYPE A/B ROTATING CLIP ¹

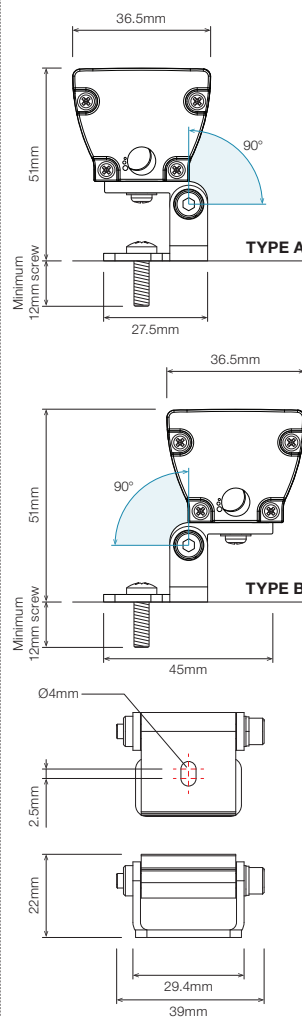

ELEVATED ROTATING MOUNTING BRACKET ^{1 2}

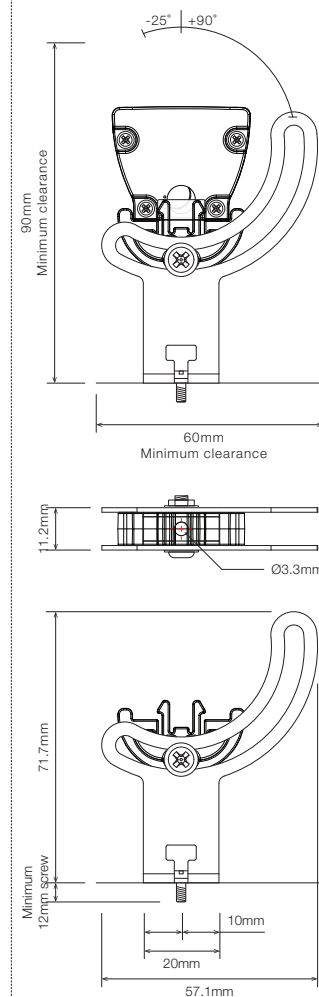

¹ Recommended spacing between Mounting Brackets is maximum 500mm and Mounting Clips is maximum 300mm.

² Elevated rotating bracket is the only suitable option when wire from back is required.

■ PRODUCT LENGTH

FULL SEGMENTS	EXACT STRIP LENGTH	FINAL LENGTH
S1	240mm	290mm
S2	480mm	530mm
S3	720mm	770mm
S4	960mm	1,010mm
S5	1,200mm	1,250mm
S6	1,440mm	1,490mm
S7	1,680mm	1,730mm
S8	1,920mm	1,970mm
S9	2,160mm	2,210mm
S10	2,400mm	2,450mm
S11	2,640mm	2,690mm
S12	2,880mm	2,930mm

■ POLAR DISTRIBUTION

OPTIC		POLAR DISTRIBUTION
14D Narrow Beam 14° Beam Angle		
30D Medium Beam 30° Beam Angle		
50D Wide Beam 50° Beam Angle		
F10020D Flare Beam Flare 100° x 20° Beam Angle		
O4018D Oval Beam Oval 40° x 18° Beam Angle		
R4018D Oval Rotated Beam Oval 18° x 40° Beam Angle		

▪ DIFFUSER

SC · Standard Clear Cover

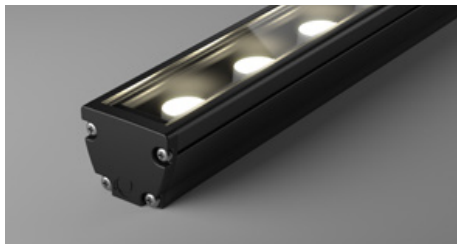

HL · Honeycomb Louvre



ML · Micro Louvre

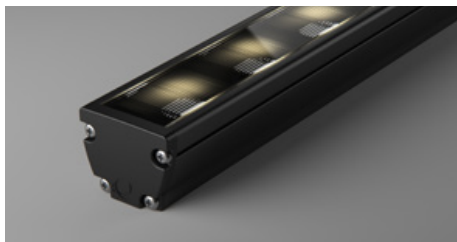

▪ PROFILE COLOUR

BLK · Black

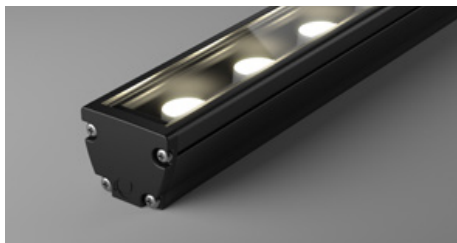

WHT · White

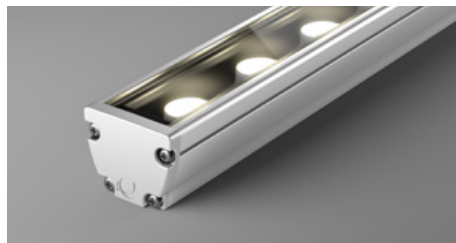





CST · Custom Colour ¹

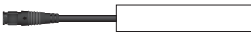

¹ Custom colours available on request

WIRING CONFIGURATION

CONNECTOR TYPE	DRAWING	MALE	FEMALE
OC2.2MO Outdoor Connector 2.2pin Male Only			
SMP LC.1 Sample Type Connector 2.5mm			

- Typical wiring length 1,000mm.
- Please consult Coolon for details on extension cable between LED fittings, drivers and power supplies.

WIRING COLOUR CODE	
Red	+ VDC
Black	GND
White	Dimming

WIRING POSITION

WB - Wire from back



Ideal for fittings installed end-to-end or limited spaces.

WS - Wire from Side



Ideal for fittings installed individually or vertically.

IP RATING

IP66

Fully protected against dust.
Protected against wave-like water jets from all directions.

INSTALLATION LIMITS

SCENARIO 1

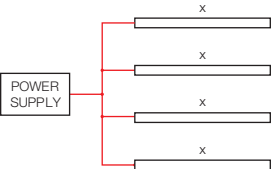

MAX. CONTINUOUS CONNECTION LENGTH (X)	CONNECTOR TYPE
---------------------------------------	----------------

2,930 mm	With standard 2+1 bare wires (WR2.10S)
----------	--

- Please consult Coolon for details on extension cable between LED fittings, drivers and power supplies.

WARNING

Avoid connecting multiple power supplies into a single circuit, unless they are specifically designed to do so.

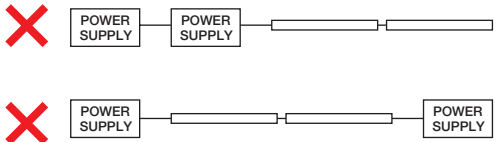

■ ORDERING EXAMPLE

LNR - MAX MINI IP - 3.5KCRI - S2 - O4018D - PC - BLK - OC2.2MO - WB - IP66

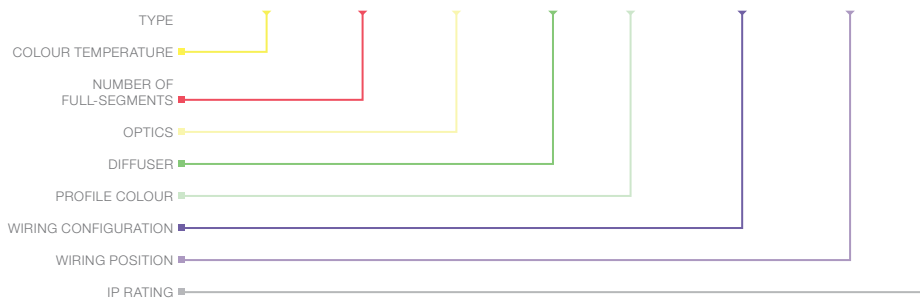

■ **COLOUR TEMPERATURE** PAGE 04

2.7KCRI	2700K CRI 90
3.0KCRI	3000K CRI 90
3.5KCRI	3500K CRI 90
4.0KCRI	4000K CRI 90

■ **PRODUCT LENGTH** PAGE 06

S1	290mm
S2	530mm
S3	770mm
S4	1010mm
S5	1,250mm
S6	1,490mm
S7	1,730mm
S8	1,970mm
S9	2,210mm
S10	2,450mm
S11	2,690mm
S12	2,930mm

■ **OPTICS** PAGE 06

14D	14° Beam
30D	30° Beam
50D	50° Beam
F10020D	Flare 100° x 20° Beam
O4018D	Oval 40° x 18° Beam
R4018D	Oval 18° x 40° Beam

■ **DIFFUSER** PAGE 07

PC	Polyurethane Clear
HL	Honeycomb Louvre
ML	Micro Louvre

■ **PROFILE COLOUR** PAGE 07

BLK	Black (Standard)
WHT	White
CST	Custom Colour ¹

■ **WIRING CONFIGURATION** PAGE 08

OC2.2MO	Outdoor Connector 2.2pin Male Only
SMPLC.1	Sample Type Connector 2.5mm

■ **WIRING POSITION** PAGE 08

WB	Wire from Back
WS	Wire from Side

■ **IP RATING** PAGE 08

IP66	Outdoor Use
------	-------------

¹ Custom colours available on request

■ ACCESSORIES

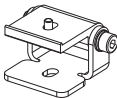
	PRODUCT CODE	DESCRIPTION
MOUNTING ¹		
	MC-CCLIP	Stainless Steel C-Clip
	MBR-RB-TA-MAX-BLK	Rotating Bracket, TYPE A Rotating Clip - Black
	MBR-RB-TB-MAX-BLK	Rotating Bracket, TYPE B Rotating Clip - Black
	MBR-PMAX-E-BLK	Elevated Rotating Mounting Bracket for Max Mini - Black
	MBR-PMAX-E-WHT	Elevated Rotating Mounting Bracket for Max Mini - White

¹ Recommended spacing between Mounting Brackets is maximum 500mm and Mounting Clips is maximum 300mm.

	PRODUCT CODE	DESCRIPTION
CONTROLLER		
	CTR-A2PWM 0-10V	Analogue to PWM converter for 0-10V dimming signal
	CTR-DIMMERLOGIC	Coolon Universal Wall Dimmer with 0-10V and PWM Logic Output
	CTR-DALI-LOGIC	Indoor DALI Point 1 channel Driver with PWM Logic Output
	CTR-DALILOGIC-IP	Outdoor DALI Point 1 channel Driver with PWM Logic Output

	PRODUCT CODE	DESCRIPTION
POWER SUPPLY FOR OUTDOOR USE		
	PWR-HLG-60H-24AU	Mean Well Power Supply HLG 60W 24V IP67
	PWR-HLG-150H-24AU	Mean Well Power Supply HLG 150W 24V IP67
	PWR-HLG-240H-24AU	Mean Well Power Supply HLG 240W 24V IP67
	PWR-HLG-320H-24AU	Mean Well Power Supply HLG 320W 24V IP67

	PRODUCT CODE	DESCRIPTION
CABLE EXTENSIONS		
	CBLEXT-LNR-WR2.1-IP65-3M	3m Length, 3 Core RBW 16AWG Cable Extension with outdoor joiner
	CBLEXT-LNR-WR2.1-IP65-5M	5m Length, 3 Core RBW 16AWG Cable Extension with outdoor joiner
	CBLEXT-LNR-WR2.1-IP65-10M	10m Length, 3 Core RBW 16AWG Cable Extension with outdoor joiner
	CBLEXT-LNR-WR2.1-IP65-20M	20m Length, 3 Core RBW 16AWG Cable Extension with outdoor joiner
	CBLEXT-LNR-WR2.1-IP65-30M	30m Length, 3 Core RBW 16AWG Cable Extension with outdoor joiner